

2026

Nice



# Nice To Have

I prodotti Nice più richiesti,  
ai migliori prezzi

[Niceforyou.com](http://Niceforyou.com)

Scopri le soluzioni Nice  
ad un prezzo speciale  
dal 01/03/2026 al 31/12/2026

# Automazioni connesse.

Vantaggio operativo per il professionista, valore aggiunto per il cliente.

## Un'automazione connessa agevola il lavoro del professionista perchè:

- L'interfaccia plug-in **BiDi-WiFi** si innesta nella centrale e **genera automaticamente una rete WiFi** che consente la **programmazione dei parametri motore** comodamente via **MyNice Pro app**, puoi usare la stessa interfaccia **per programmare tutti gli impianti**;
- Consente la **diagnostica e assistenza a distanza** in caso di anomalie;
- Grazie alla MyNice Pro app è possibile avere accesso a **manuali**, allo **storico installazioni** e molte altre funzionalità pratiche ed efficaci.

## Un'automazione connessa è un valore aggiunto per il cliente perchè:

L'interfaccia plug-in **BiDi-WiFi** innestata stabilmente nella centrale **consente di connettere il motore alla rete WiFi di casa e quindi:**

- Aprire e chiudere l'automazione via **MyNice app** e con **comandi vocali** e verificarne lo stato;
- Ricevere **notifiche** nel caso in cui il portone venga forzato o presenti anomalie;
- Creare **scenari personalizzati**;
- Ottenere **assistenza a distanza**.

PROGETTATO PER  
GLI INSTALLATORI



### MyNice Pro App

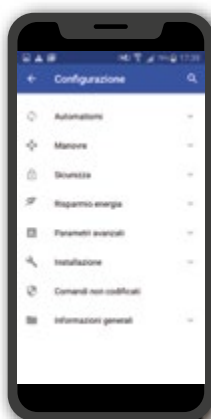

**Configura e fornisci assistenza da remoto**, garantendo sempre una connessione affidabile.



PROGETTATO PER  
I CONSUMATORI FINALI



### MyNice App

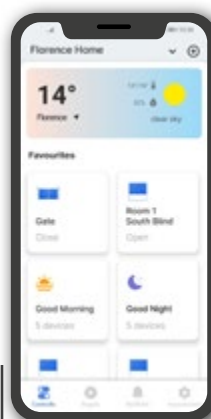

**Controlla cancelli e porte da garage tramite smartphone**, con una connessione affidabile.

**Con BiDi-WiFi dedicato all'utente installato nella centrale.**



## Come connettere il cancello, la barriera e/o la porta da garage in modo semplice?

### Scopri BiDi-WiFi

Interfaccia plug-in di comunicazione per il controllo delle automazioni Nice via Smartphone tramite Wi-Fi.

Cod. BIDI-WIFI



#### Generazione automatica rete WiFi

che permette la configurazione dell'automazione, tramite app MyNice Pro comodamente dal tuo mezzo.

### Plug-in & Go!

Innesta, configuri e vai con l'interfaccia plug-in tascabile



€71,50

€44,00

Listino Ribassato



GUARDA QUANTO È SEMPLICE!

## Serve estendere la portata del segnale WiFi?

### Scopri BiDi-WiFi EXT, fino a 100 m di portata.

Cod. BIDI-WIFI EXT



€135,50

€122,50

Listino Ribassato

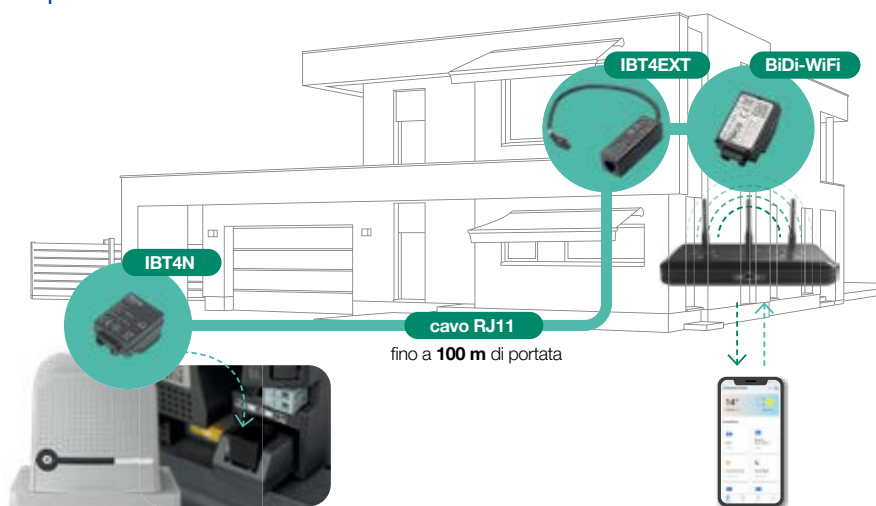

Interfaccia per la gestione e programmazione di trasmettitori monodirezionali e l'aggiornamento firmware delle centrali R10 e versioni precedenti.

### Pro-View



€451,50

€354,00

Listino Ribassato

# Scopri come integrare nel sistema Smart Home anche automazioni per cancelli e porte da garage già installate e gestirle comodamente da App o tramite comandi vocali Amazon Alexa, Google Assistant.

## Yubii Home e Yubii Home app

Collega le automazioni attraverso il gateway Nice per creare scenari personalizzati che possono essere gestiti sia da smartphone sia impostando un tasto sul telecomando bidirezionale.

**Yubii® Home**  
Cod. YH-001

## Yubii Home App



GET IT ON  
Google Play

Download on the  
App Store

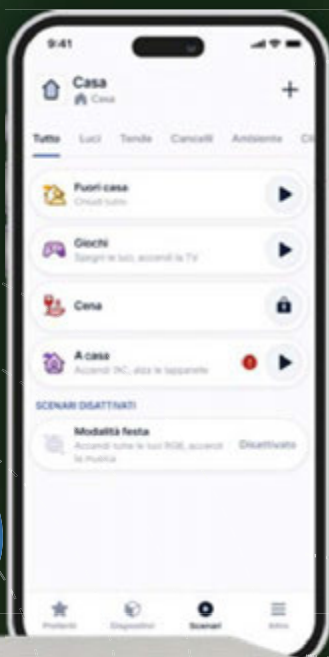

€ 272,00

€ 237,00

Listino  
Ribassato

Yubii Home

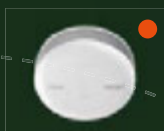

**Smoke-Control**  
Per rilevare la presenza di fumo in casa.

€ 154,00

€ 130,00

Listino  
Ribassato



**BiDi-ZWave**  
Interfaccia plug-in di comunicazione tra gateway Z-Wave™ e motori Nice.



**SingleSwitch-Control**  
Per il comando di un dispositivo on-off.



**MyEye Cameras**  
Per osservare l'area monitorata in diretta in alta risoluzione.



**Door/Window-Control**  
Per rilevare l'apertura di porte/finestre e come sensore di temperatura.



**BiDi-Switch**  
Per la gestione di luci e carichi elettrici con misurazione del consumo elettrico.

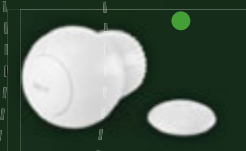

**Heat-Control**  
Per gestire radiatori in modo intelligente.



**BiDi-MiniShutter**  
Il nuovo modulo compatto per il controllo senza sforzo di avvolgibili.



**CO-Control**  
Per individuare la presenza di monossido di carbonio.



**DoubleDimmer-Control**  
Modulo universale per la regolazione dell'intensità luminosa, compatibile con varie fonti di luce.

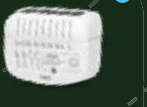

**On/Off-Control2**  
Per il comando a distanza di due circuiti o apparecchi secondo il principio on-off.



**RGBW-Control**  
Per il controllo cromatico delle luci.

Compatibile con:

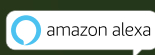

Comunica tramite i protocolli:



Radio Nice

Radio elero

# L'app super intuitiva per il controllo dell'ecosistema casa

Gestione semplificata di tutti i devices **radio Nice** e **Z-Wave** della casa tramite smartphone, interfaccia intuitiva, configurazione rapida e guidata.

Yubii® Home



Configurazione rapida ed intuitiva

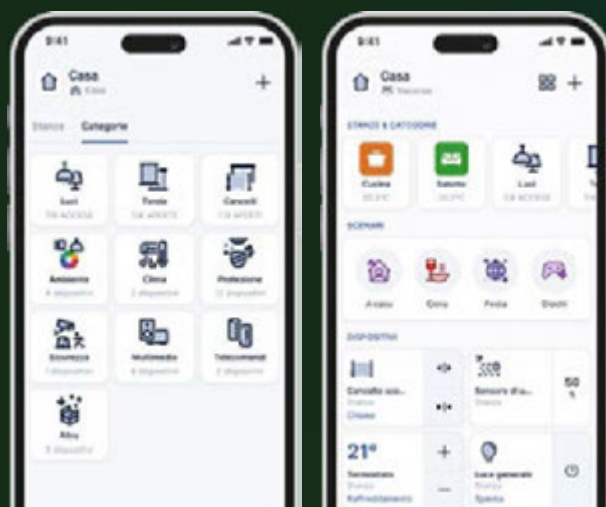

## Con Yubii Home puoi gestire in modo smart tutta la casa

- Luci
- Riscaldamento e raffreddamento
- Automazioni e dispositivi
- Dispositivi per **Controllo e sicurezza**
- Dispositivi per il comfort
- Intercom



# Nice per cancelli scorrevoli



Blue BUS 24V Sole myo BiDi Yubii

## RobusKit 400 BD Cod. RBS400BDKCE

Per cancelli fino a 400 Kg

Blue BUS 24V Sole myo BiDi Yubii

Il Kit include:

1 motoriduttore irreversibile, 24 Vdc con centrale e ricevente integrata

1 PZ. RBS400



€ 1.104,50

€ 915,50

Listino Ribassato



## RobusKit 600 BD Cod. RBS600BDKCE

Per cancelli fino a 600 Kg

Blue BUS 24V Sole myo BiDi Yubii

Il Kit include:

1 motoriduttore irreversibile, 24 Vdc con centrale e ricevente integrata

1 PZ. RBS600



€ 1.185,00

€ 1.030,00

Listino Ribassato



## RobusKit 800 BD Cod. RBS800BDKCE

Per cancelli fino a 800 Kg

Blue BUS 24V Sole myo BiDi Yubii

1 motoriduttore Irreversibi 24 Vdc, con centrale incorporata e ricevitore OXIBD, fincorsa elettromeccanico

1 PZ. RBS800



€ 1.327,00

€ 1.150,00

Listino Ribassato



## Run 1500 Cod. RUN1500

Per cancelli fino a 1500 Kg

Blue BUS 24V Sole myo BiDi Yubii

1 motoriduttore irreversibile, 24 Vdc con centrale integrata, fincorsa elettromeccanico

1 PZ. RUN1500



€ 1.509,50

€ 1.425,00

Listino Ribassato



\*L'elettronica di comando all'interno del kit potrà variare durante il periodo promozionale

# Nice per cancelli scorrevoli



Completa il tuo impianto con gli accessori Nice!



**PPH3**  
€ 121,00



**EPM**  
€ 106,50



**EPMB**  
€ 128,00



**EKS**  
€ 52,00



**EDSWG**  
€ 180,00



**EDSB**  
€ 178,50



**ELDC**  
€ 85,50



**OXIBD**  
€ 97,00



**MYGO4**  
€ 66,00



**MLAE21**  
€ 52,00



**MLAE22**  
€ 59,50



**MLAE44**  
€ 64,50



**CBIPLEX704**  
€ 59,50  
€ 47,00



**CBIPLEX720**  
€ 59,50  
€ 47,00



**CBIPLEX740**  
€ 59,50  
€ 47,00



**CBIPLERB6**  
€ 59,50  
€ 47,00



**ROA66**  
€ 30,20



**ROA8**  
€ 36,40

Accessori opzionali			Compatibilità			
Codice	Descrizione	Pz. Conf.	RBS400BDKCE	RBS600BDKCE	RBS800BDKCE	RUN1500
<b>PPH3</b>	Colonnina in alluminio per fotocellule	2	•	•	•	•
<b>EPM</b>	1 Coppia di fotocellule	1	•	•	•	•
<b>EPMB</b>	1 Coppia di fotocellule BlueBUS	1	•	•	•	•
<b>EKS</b>	Selettore a chiave	1	•	•	•	•
<b>EDSWG</b>	Selettore Digitale 13 tasti, wireless	1	•	•	•	•
<b>EDSB</b>	Selettore Digitale 12 tasti, via cavo BlueBUS	1	•	•	•	•
<b>ELDC</b>	Luce di segnalazione lampeggiante a LED 12-36 Vdc	1	•	•	•	•
<b>OXIBD</b>	Ricevitore radio a innesto, bidirezionale	1	•	•	•	•
<b>MYGO4</b>	Trasmettitore a 4 canali	1	•	•	•	•
<b>MLAE21</b>	Scheda di espansione plug-in 1 Output 2 Input	1	•	•	•	•
<b>MLAE22</b>	Scheda di espansione plug-in 2 Output (1 Relè 230V) 2 Input	1	•	•	•	•
<b>MLAE44</b>	Scheda di espansione plug-in 4 Output 4 Input	1	•	•	•	•
<b>CBIPLEX704</b>	Piastre di adattamento, terze parti	1	•	•	•	•
<b>CBIPLEX720</b>	Piastre di adattamento, terze parti	1	•	•	•	•
<b>CBIPLEX740</b>	Piastre di adattamento, terze parti	1	•	•	•	•
<b>CBIPLERB6</b>	Piastre di adattamento Robus	1	•	•	•	•
<b>ROA66</b>	Cremagliera M4 25x20x1000 mm asolata in nylon con inserto metallico e sei punti di fissaggio evidenziati.	10	•	•	•	•
<b>ROA8</b>	Cremagliera M4 30x8x1000 mm zincata, completa di viti e distanziali	10				•

## Esempio d'installazione per cancelli scorrevoli

1. Motore
2. Trasmettitore
3. Fotocellule a colonna
4. Fotocellule
5. Luce lampeggiante
6. Selettore a chiave
7. Sensore per bordo sensibile
8. Pannello solare SYP
9. Box batteria PSY24
10. Interfaccia multifunzione Pro-View

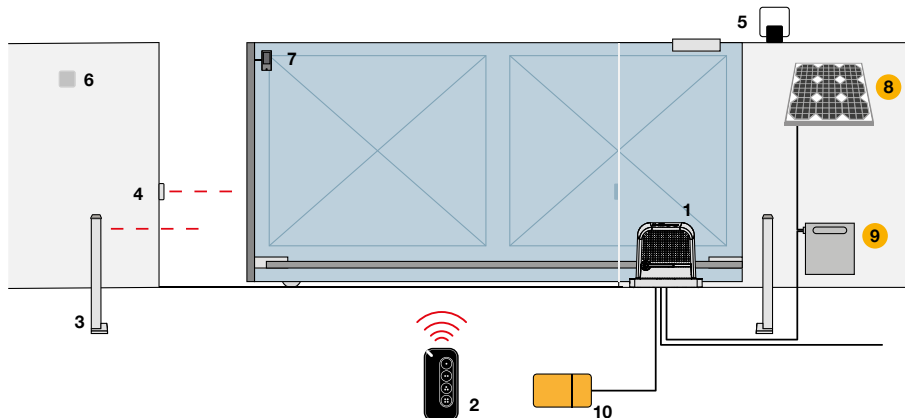

- Accessori disponibili anche nella versione wireless **Solemyo Air Net System**
- Accessori alimentazione solare **Solemyo**

# Nice per cancelli scorrevoli



230V

## RoboKit 600 Cod. RO600KCE

Per cancelli fino a 600 Kg

230V

Il Kit include:

1 motore irreversibile, 230 V, finecorsa meccanico con centrale e ricevente incorporate

1 PZ. RO600



€1.133,00  
**€ 863,50**  
Listino  
Ribassato



## RoboKit 1000 Cod. RO1000KCE

Per cancelli fino a 1000 Kg

230V

Il Kit include:

1 motore irreversibile, 230 V, finecorsa meccanico con centrale e ricevente incorporate

1 PZ. RO1000



€1.238,00  
**€ 1.100,00**  
Listino  
Ribassato

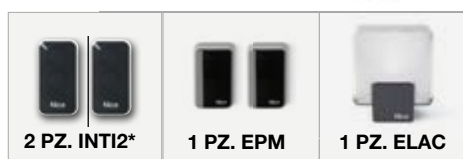

## RoboKit 1500 Cod. RO1500KCE

Per cancelli fino a 1500 Kg

230V

Il Kit include:

1 motore irreversibile, 230 V, finecorsa meccanico con centrale e ricevente incorporate

1 PZ. RBS1500



€1.489,00  
**€ 1.340,00**  
Listino  
Ribassato



# Nice per cancelli scorrevoli



Completa il tuo impianto con gli accessori Nice!



**PPH3**  
€ 121,00



**EPM**  
€ 106,50



**EKS**  
€ 52,00



**EDSWG**  
€ 180,00



**EDS**  
€ 134,50



**ELAC**  
€ 76,00



**MYGO4**  
€ 66,00



**MORX**  
€ 152,00



**CBIPLEX704**  
€ 59,50  
€ 47,00



**CBIPLEX720**  
€ 59,50  
€ 47,00



**CBIPLEX740**  
€ 59,50  
€ 47,00



**CBIPLEXB6**  
€ 59,50  
€ 47,00

Accessori opzionali			Compatibilità		
Codice	Descrizione	Pz. Conf.	RO600KCE	RO1000KCE	RO1500KCE
<b>PPH3</b>	Colonnina in alluminio per fotocellule	2	•	•	•
<b>EPM</b>	1 Coppia di fotocellule	1	•	•	•
<b>EKS</b>	Selettore a chiave	1	•	•	•
<b>EDSWG</b>	Selettore Digitale 13 tasti, wireless	1	•	•	•
<b>EDS</b>	Selettore Digitale 12 tasti	1	•	•	•
<b>ELAC</b>	Luce di segnalazione lampeggiante a led, 90-240 Vac	1	•	•	•
<b>MYGO4</b>	Trasmittitore a 4 canali	1	•	•	•
<b>MORX</b>	Decoder per 1 lettore di prossimità ETP	1	•	•	•
<b>CBIPLEX704</b>	Piastre di adattamento, terze parti	1	•		
<b>CBIPLEX720</b>	Piastre di adattamento, terze parti	1	•		
<b>CBIPLEX740</b>	Piastre di adattamento, terze parti	1	•		
<b>CBIPLEXB6</b>	Piastre di adattamento Robus	1	•		

## Esempio d'installazione per cancelli scorrevoli

1. Motore
2. Trasmittitore
3. Fotocellule a colonna
4. Fotocellule
5. Luce lampeggiante
6. Selettore a chiave
7. Sensore per bordo sensibile

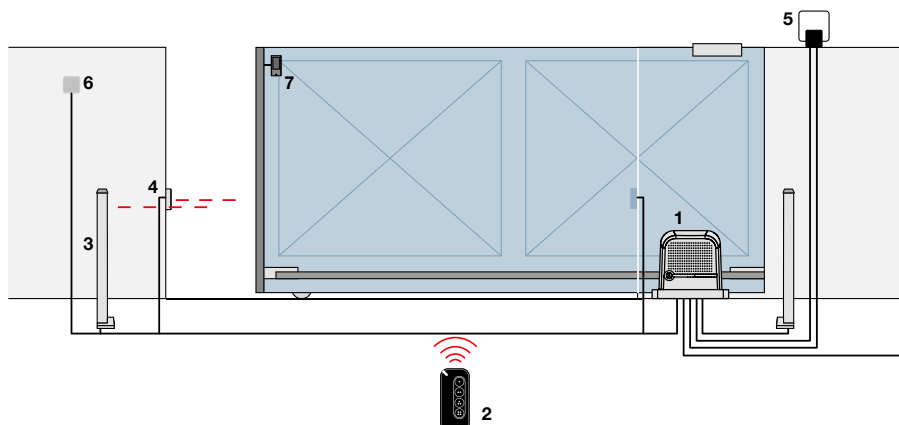

# Nice per cancelli a battente



## WingoKit 4024 BD Cod. WINGO4024BDKCE

Per cancelli con ante fino a 2 m



Il Kit include:

2 Motoriduttori elettromeccanici con sblocco a chiave Nice e finecorsa meccanico in apertura

2 PZ. WG4024

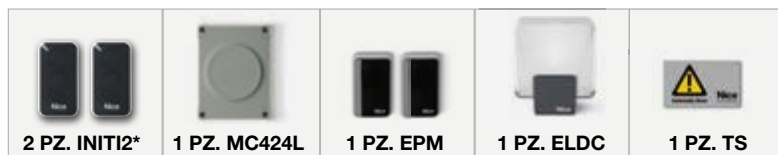

~~€ 1.511,50~~  
**€ 1.352,00**  
 Listino Ribassato



## ToonaKit BD Cod. TOONA4024BDKCE

Per cancelli con ante fino a 3 m



Il Kit include:

2 Motoriduttori elettromeccanici irreversibili a montaggio esterno con arresto meccanico in apertura

2 PZ. TO4024



~~€ 1.919,00~~  
**€ 1.747,50**  
 Listino Ribassato



# Nice per cancelli a battente



Completa il tuo impianto con gli accessori Nice!



Codice	Descrizione	Pz. Conf.	Compatibilità	
			WINGO4024BDKCE	TOONA4024BDKCE
<b>PPH3</b>	Colonnina in alluminio per fotocellule	2	•	•
<b>MC824H</b>	Centrale di comando per uno o due motori irreversibili a 24 V con encoder	1		•
<b>MC424L</b>	Centrale di comando con ricevitore radio integrato e ricevitore radio bidirezionale ad innesto OXIBD incluso	1	•	
<b>EPM</b>	1 Coppia di fotocellule	1	•	
<b>EPMB</b>	1 Coppia di fotocellule BlueBUS	1		•
<b>EDSWG</b>	Selettore Digitale 13 tasti, wireless	1	•	•
<b>EDSB</b>	Selettore Digitale 12 tasti, via cavo BlueBUS	1		•
<b>OXIBD</b>	Ricevitore radio a innesto, bidirezionale	1	•	•
<b>EDS</b>	Selettore Digitale 12 tasti	1	•	•
<b>MORX</b>	Decoder per 1 lettore di prossimità ETP	1	•	•

## Esempio d'installazione per cancelli a battente

1. Motore
2. Trasmettitore
3. Fotocellule a colonna
4. Fotocellule
5. Luce lampeggiante
6. Centrale di comando
7. Selettore digitale o selettore a chiave
8. Pannello solare SYP
9. Box batteria PSY24
10. Interfaccia multifunzione Pro-View

- Accessori disponibili anche nella versione wireless **Solemyo Air Net System**
- Accessori alimentazione solare **Solemyo**

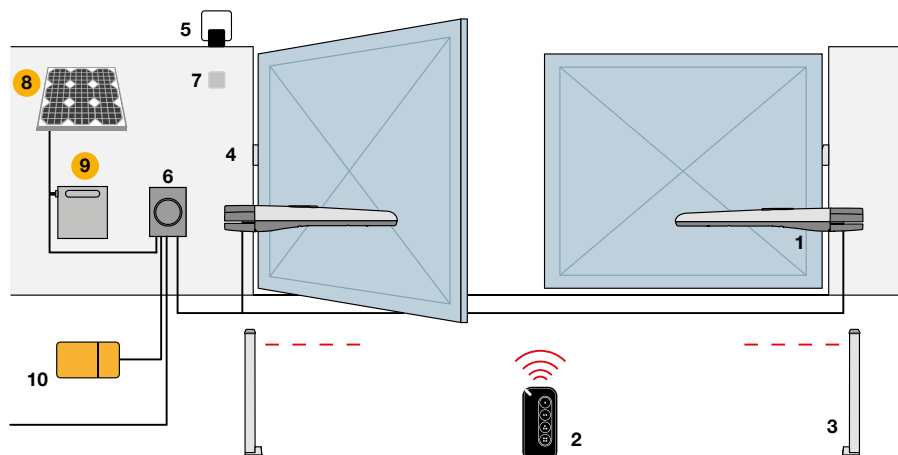

# Nice per cancelli a battente montaggio interrato



## M-FabKit 3024 BD Cod. MFAB3024BDKCE

Per cancelli con ante fino a 3 m



Il Kit include:

2 motoriduttori irreversibili, 24 Vdc, con encoder magnetico e fermo meccanico in chiusura

2 PZ. MFAB3024



~~€ 2.092,50~~  
**€ 1.893,00**  
Listino Ribassato



~~€ 554,00~~  
**€ 406,00**  
Listino Ribassato

2 casse di fondazione  
2 PZ. MFABBOX

## L-Fab Cod. LFAB4024

Per cancelli con ante fino a 4 m



2 motoriduttori irreversibili 24 Vdc, con encoder magnetico e con finecorsa meccanico in chiusura

2 PZ. LFAB4024



~~€ 1.496,00~~  
**€ 1.342,00**  
Listino Ribassato



~~€ 731,00~~  
**€ 520,00**  
Listino Ribassato

2 casse di fondazione  
in cataforesi  
2 PZ. LFABBOX4



\*L'elettronica di comando all'interno del kit potrà variare durante il periodo promozionale

# Nice per cancelli a battente montaggio interrato



Completa il tuo impianto con gli accessori Nice!



**EPMB**  
€ 128,00



**MC824H**  
€ 539,00



**OXIBD**  
€ 97,00



**MYGO4**  
€ 66,00



**ELDC**  
€ 85,50



**BMA2**  
€ 28,00



**BMA3**  
€ 125,00



**MEA3**  
€ 250,00

Codice	Descrizione	Pz. Conf.	Compatibilità	
			MFAB3024BDKCE	LFAB4024
<b>EPMB</b>	1 Coppia di fotocellule BlueBUS	1	•	•
<b>MC824H</b>	Centrale di comando per uno o due motori irreversibili a 24 V con encoder	1	•	•
<b>OXIBD</b>	Ricevitore radio a innesto, bidirezionale	1	•	•
<b>MYGO4</b>	Trasmettitore a 4 canali	1	•	•
<b>ELDC</b>	Luce di segnalazione lampeggiante a LED 12-36 Vdc	1	•	•
<b>BMA2</b>	Adattatori per l'installazione di due motori L-Fab, compatibili con la maggior parte delle casse di fondazione in commercio	1		•
<b>BMA3</b>	Sblocchi con chiave a leva per LFAB	2		•
<b>MEA3</b>	Sblocchi a leva per MFAB	2	•	

## Esempio d'installazione a montaggio interrato

1. Motore
2. Trasmettitore
3. Fotocellule a colonna
4. Fotocellule
5. Luce lampeggiante
6. Centrale di comando
7. Selettore digitale o selettore a chiave
8. Pannello solare SYP
9. Box batteria PSY24
10. Interfaccia multifunzione Pro-View

- Accessori disponibili anche nella versione wireless **Solemyo Air Net System**
- Accessori alimentazione solare **Solemyo**

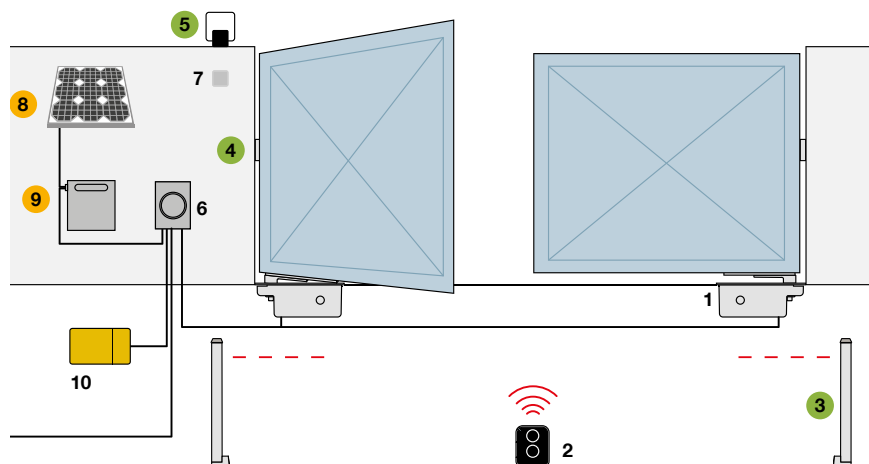

# Nice per porte da garage



## SpiderKit 800W Cod. SPIDER32BDWKCE

Per porte sezionali fino a 11,4 m<sup>2</sup> e basculanti fino a 12,6 m<sup>2</sup>



Il Kit include:

Motoriduttore con WiFi **integrato**, centrale di comando e ricevitore BiDirezionale

1 PZ. SPIDER800W



1 PZ. SR32B

2 PZ. MYGO4\*

€ 929,00

€ 728,00

Listino Ribassato



## Tenkit Cod. TNLKCE

Per porte basculanti debordanti e non debordanti fino a 9 m<sup>2</sup> e 2,6 m di altezza

24V

1 Motoriduttore con centrale e ricevitore incorporati, completo di 1 coppia di bracci telescopici TNA5 e relativi dispositivi di rinvio TNA38

1 PZ. TNLKCE



1 PZ. INTI2

1 PZ. TS

€ 965,50

€ 894,50

Listino Ribassato



# Nice per porte da garage



Completa il tuo impianto con gli accessori Nice!



**EPS**  
€ 100,00



**EPSB**  
€ 123,00



**EDSWG**  
€ 180,00



**ELDC**  
€ 85,50



**ELAC**  
€ 76,00



**SPA5**  
€ 201,00



**SPA2**  
€ 36,50



**OTA2**  
€ 56,50



**OTA11**  
€ 36,50



**TNA4**  
€ 54,00

Accessori opzionali			Compatibilità	
Codice	Descrizione	Pz. Conf.	SPIDER32BDWKCE	TNLKCE
EPS	1 Coppia di fotocellule slim da esterno	1	•	•
EPSB	Coppia di fotocellule Slim da esterno, per collegamento via Nice BlueBUS	1	•	
EDSWG	Selettore Digitale 13 tasti, wireless	1	•	•
ELDC	Luce di segnalazione lampeggiante a LED 12-36 Vdc	1	•	•
ELAC	Luce di segnalazione lampeggiante a led, 90-240 Vac	1		
SPA5	Braccio oscillante con scorrimento a cuscinetti e geometria ottimizzata per porte basculanti debordanti	1	•	
SPA2	Kit per lo sblocco dall'esterno con cordino metallico	1	•	
OTA2	Staffa supporto motore di lunghezza 1250 mm	1		•
OTA11	Kit per sblocco dall'esterno con cordino metallico	1		•
TNA4	Coppia di alberi di trasmissione 20x20 mm, di lunghezza 1500 mm	1		•

## Esempio d'installazione Spider su porta sezionale

1. Motore
2. Trasmettitore
3. Fotocellule
4. Luce lampeggiante
5. Selettore a chiave o digitale
6. Sensore per bordo sensibile
7. Pannello solare SYP
8. Box batteria PSY24
9. Interfaccia multifunzione Pro-View

- Accessori disponibili anche nella versione wireless **Solemyo Air Net System**
- Accessori alimentazione solare **Solemyo**

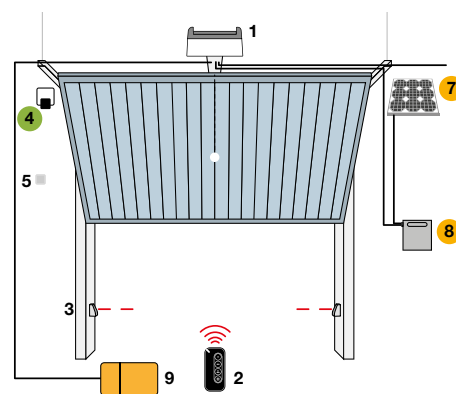

## Esempio d'installazione Ten su porta basculante

1. Motore
2. Trasmettitore
3. Fotocellule
4. Luce lampeggiante
5. Selettore a chiave o digitale
6. Pannello solare SYP
7. Box batteria PSY24
8. Interfaccia multifunzione Pro-View

- Accessori disponibili anche nella versione wireless **Solemyo Air Net System**
- Accessori alimentazione solare **Solemyo**

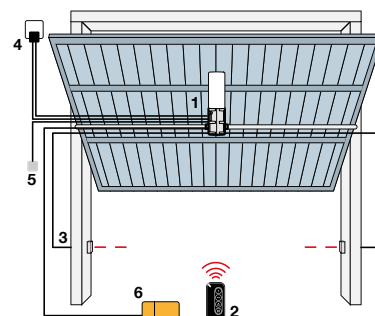

# Nice per serrande bilanciate



## Rondo Kit Cod. RN2040E02KCE

Per serrande bilanciate fino a 170 kg

24V

Il Kit include:

1 Motore irreversibile, con elettrofreno e dispositivo di sblocco

1PZ. RN2040



€ 799,50

€ 562,00

Listino Ribassato



## Completa il tuo impianto con gli accessori Nice!



EPS  
€ 100,00



EDSWG  
€ 180,00



ELAC  
€ 76,00



RNA02  
€ 10,50

## Esempio d'installazione Rondo

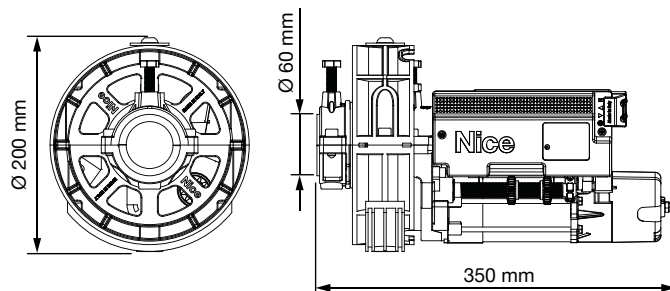
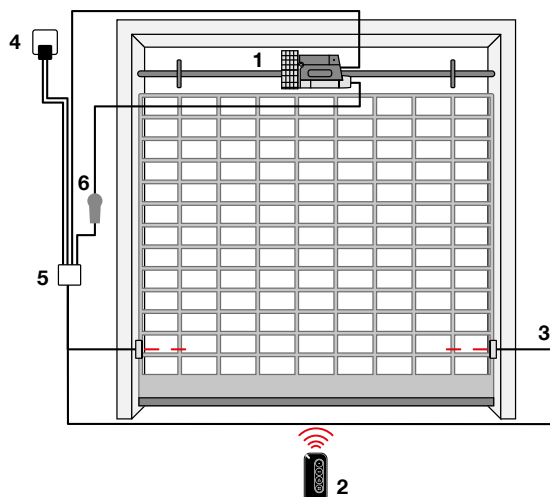

1. Motore 2. Trasmettitore 3. Fotocellule 4. Luce lampeggiante 5. Centrale di comando 6. Selettore a chiave o digitale

# Nice per sistemi alzabarriera



## S-Bar PROMOKIT

Per accessi di 4 m



Il Kit include:

1 sistema alzabarriera elettromeccanico, motoriduttore 24 Vdc, irreversibile 230 Vac con base di ancoraggio, per aste da 4 m

1 PZ. S4BAR



€ 2.176,00

€ 1.933,00

Listino Ribassato

## Completa il tuo impianto con gli accessori Nice!

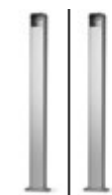

PPK

€ 171,00



PPH3

€ 121,00



XBA4

€ 104,00



XBA13

€ 94,00



WA10

€ 42,50



WA11

€ 133,50



HSB1

€ 227,00



ETPB

€ 163,50



ELDC

€ 85,50



MYGO4

€ 66,00



EDSWG

€ 180,00



OXIBD

€ 97,00



EDSB

€ 178,50



EPMB

€ 128,00



LP21

€ 326,00



SYKCE30

€ 1.106,00

€ 998,50

## Esempio d'installazione S-Bar

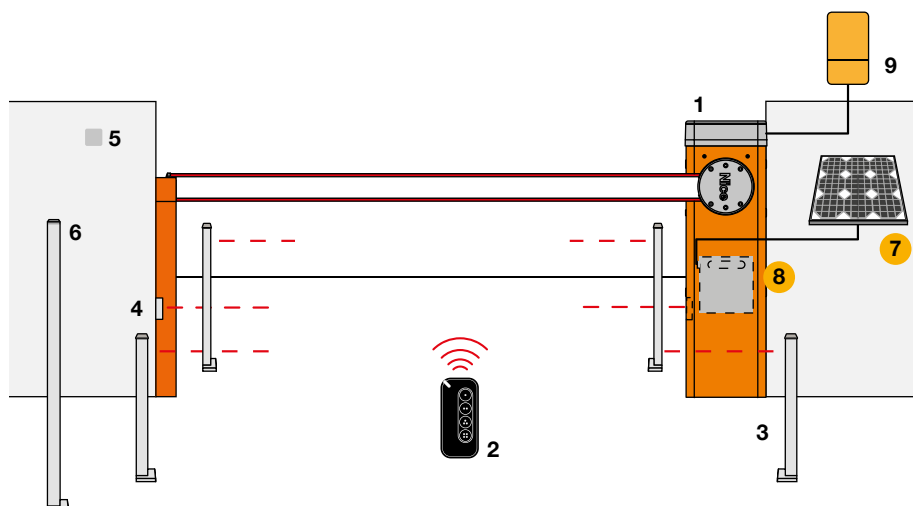

1. Motore 2. Trasmettitore 3. Fotocellule a colonna  
4. Fotocellule 5. Selettore a chiave o digitale  
6. Selettore a chiave o digitale su colonna 7. Pannello solare SYP 8. Box batteria PSY24 9. Interfaccia multifunzione Pro-View

● Accessori disponibili anche nella versione wireless

**Solemyo Air Net System**

● Accessori alimentazione solare **Solemyo**

# Nice per sistemi alzabarriera



## M-Bar 5 PROMOKIT

Per accessi di 5 m



Il Kit include:

1 sistema alzabarriera elettromeccanico motoriduttore 24 Vdc, irreversibile 230 Vac, con base di ancoraggio, per aste da 4 o 5 m

1 PZ. M5BAR



€3.129,00  
€ **2.726,50**  
Listino Ribassato

Disponibile in:

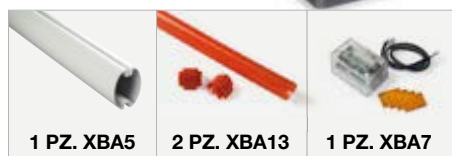

## M-Bar 7 PROMOKIT

Per accessi di 7 m



Il Kit include:

1 sistema alzabarriera elettromeccanico, motoriduttore 24 Vdc, irreversibile 230 Vac, con base di ancoraggio, per aste da 5, 6, 7 m

1 PZ. M7BAR



€3.388,50  
€ **2.935,00**  
Listino Ribassato

Disponibile in:



## L-Bar 9 PROMOKIT

Per accessi di 9 m



Il Kit include:

1 sistema alzabarriera elettromeccanico, motoriduttore 24 Vdc, irreversibile 230 Vac, con base di ancoraggio, per aste fino a 9 m

1 PZ. L9BAR



€5.061,00  
€ **4.276,50**  
Listino Ribassato

Disponibile in:



## Esempio d'installazione M/L-Bar

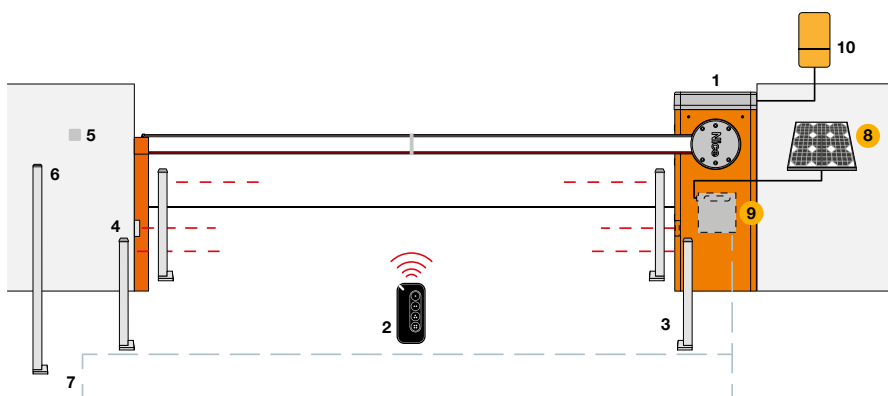

1. Motore 2. Trasmettitore 3. Fotocellule a colonna  
4. Fotocellule 5. Selettore a chiave o digitale 6. Selettore a chiave o digitale su colonna 7. Loop detector  
8. Pannello solare SYP 9. Box batteria PSY24  
10. Interfaccia multifunzione Pro-View

● Accessori disponibili anche nella versione wireless  
**Solemyo Air Net System**  
● Accessori alimentazione solare **Solemyo**

# Nice per sistemi alzabarriera

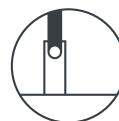

Completa il tuo impianto con gli accessori Nice!

## Luci RG e gomma trasparente



**XBA40**  
€ 104,00



**XBA60**  
€ 138,50



**XBA80**  
€ 193,50



**XBA13T**  
€ 94,00



**PPK**  
€ 171,00



**PPH3**  
€ 121,00



**XBA4**  
€ 104,00



**XBA6**  
€ 138,50



**XBA18**  
€ 193,50



**XBA13**  
€ 94,00



**WA10**  
€ 42,50



**WA11**  
€ 133,50



**HSB1**  
€ 227,00



**ETPB**  
€ 163,50



**ELDC**  
€ 85,50



**MYGO4**  
€ 66,00



**EDSWG**  
€ 180,00



**OXIBD**  
€ 97,00



**EDSB**  
€ 178,50



**EPMB**  
€ 128,00



**LP21**  
€ 326,00



**SYKCE30**  
€ 1.106,00  
€ 998,50

Codice	Descrizione	Pz. Conf.	Compatibilità			
			S-BAR	M5BAR**	M7BAR**	L9BAR**
<b>XBA40</b>	Luci RG di segnalazione con fissaggio ad innesto sull'asta, 4 m	1		•	•	•
<b>XBA60</b>	Luci RG di segnalazione con fissaggio ad innesto sull'asta, 6 m	1		•	•	•
<b>XBA80</b>	Luci RG di segnalazione con fissaggio ad innesto sull'asta, 8 m	1		•	•	•
<b>XBA13T</b>	Gomma paracolpi trasparente, 1 m	9		•	•	•
<b>PPK</b>	Colonnina in alluminio con alloggiamento per 1 selettore, 1100 mm h	2	•	•	•	•
<b>PPH3</b>	Colonnina in alluminio per fotocelle	2	•	•	•	•
<b>XBA4</b>	Luci di segnalazione con fissaggio ad innesto sull'asta, 4 m	1	•	•	•	•
<b>XBA6</b>	Luci di segnalazione con fissaggio ad innesto sull'asta, 6 m	1		•	•	•
<b>XBA18</b>	Luci di segnalazione con fissaggio ad innesto sull'asta, 8 m	1		•	•	•
<b>XBA13</b>	Gomma paracolpi rossa, 1 m	9	•	•	•	•
<b>WA10</b>	24 Strisce rosse adesive catarifrangenti	1	•	•	•	•
<b>WA11</b>	Appoggio regolabile per aste	1	•	•	•	•
<b>HSB1</b>	Badge a Transponder riprogrammabili	10	•	•	•	•
<b>ETPB</b>	Letto di prossimità per tessere a transponder, con tecnologia Nice BlueBUS	1	•	•	•	•
<b>ELDC</b>	Luce di segnalazione lampeggiante a LED 12-36 Vdc	1	•	•	•	•
<b>MYGO4</b>	Trasmittitore a 4 canali	1	•	•	•	•
<b>EDSWG</b>	Selettore Digitale 13 tasti, wireless	1	•	•	•	•
<b>OXIBD</b>	Ricevitore radio a innesto, bidirezionale	1	•	•	•	•
<b>EDSB</b>	Selettore Digitale 12 tasti, via cavo	1	•	•	•	•
<b>EPMB</b>	1 Coppia di fotocelle	1	•	•	•	•
<b>LP21</b>	Rilevatore spire magnetiche 1 canale	1	•	•	•	•
<b>SYKCE30</b>	Kit di alimentazione solare composto da pannello fotovoltaico SYP30 e box batteria PSY24 con circuito di controllo della carica e alimentatore SYA1	1	•	•	•	•

Nice

# Nice Italia, una squadra al tuo servizio:

## Online su [niceforyou.it](http://niceforyou.it) sezione supporto:

- Video di installazione e domande frequenti
- Manuali di istruzione
- Aggiornamenti Software e firmware
- Documentazione di prodotto

## Corsi di formazione on-line e @ TheNicePlace

Per supportarti nelle tecniche d'installazione e programmazione per impianti ad "opera d'arte".

## Una linea dedicata a te

# 0422.1838383

dal lunedì al venerdì  
08:30-12:30, 14:00-18:00  
e anche il sabato 09:00-12:00

Sempre informati  
e aggiornati con  
NiceService Italia.



Per vedere  
tutti i video  
tutorial Nice

Vuoi rimanere **sempre aggiornato** su Nice,  
scoprire le nostre **speciali promozioni**  
o tutte le **novità** di prodotto?

### Scansiona il QR Code,

rilascia il tuo consenso per rimanere sempre  
in contatto con noi e in pochi passi,  
farai parte del mondo Nice.

Ti aspettiamo!

Per entrare  
nel mondo  
Nice



Catalogo  
prodotti  
Gate&Door



Catalogo  
prodotti  
Smart Living



Per maggiori  
info sui  
ricambi Nice:



[Niceforyou.com](http://Niceforyou.com)